



Manual

EE371
Dew Point Transmitter / Switch
down to -60 °C Td

YOUR PARTNER IN SENSOR TECHNOLOGY



ELEKTRONIK®
Ges.m.b.H.

E+E Elektronik Ges.m.b.H. doesn't accept warranty and liability claims neither upon this publication nor in case of improper treatment of the described products.

The document may contain technical inaccuracies and typographical errors. The content will be revised on a regular basis. These changes will be implemented in later versions. The described products can be improved and changed at any time without prior notice.

**© Copyright E+E Elektronik Ges.m.b.H.
All rights reserved.**

EMC note USA (FCC):

This equipment has been tested and found to comply with the limits for a Class A digital device, pursuant to part 15 of the FCC Rules. These limits are designed to provide reasonable protection against harmful interference when the equipment is operated in a commercial environment. This equipment generates, uses, and can radiate radio frequency energy and, if not installed and used in accordance with the instruction manual, may cause harmful interference to radio communications. Operation of this equipment in a residential area is likely to cause harmful interference in which case the user will be required to correct the interference at his own expense.

EMC note Canada (ICES-003):

CAN ICES-3 (A) / NMB-3 (A)

INHALT

1	General	4
1.1	Explanation of symbols	4
1.2	Safety Instructions	4
1.2.1	General safety instructions	4
1.2.2	Mounting, start-up and operation	4
1.2.3	Intended Use	5
1.3	Environmental aspects	5
2	Product description	6
2.1	General	6
2.2	Dimensions in mm (inch)	6
2.3	Auto-calibration	6
2.4	Output scale; Output signal limitation	7
3	Installation	8
3.1	Installation location	8
3.2	Direct mounting into the process	8
3.3	Mounting with a sampling cell	9
3.3.1	Basic sampling cell	9
3.3.2	Sampling cell with quick connector	9
4	Electrical Connection	10
5	Operating components	11
5.1	Electronics board	11
5.2	Status LEDs	11
5.3	Display Module (Option)	12
6	Setup	12
7	Calibration / Adjustment	12
7.1	Definitions	12
7.2	Customer adjustment - Dew Point	12
8	Maintenance	13
8.1	Sensor cleaning and filter replacement	13
8.2	Self-diagnostic and error messages	13
9	Accessories	14
9.1	Scope of Supply	14
10	Technical Data	14

1 General

This operation manual is part of the scope of supply and serves for ensuring proper handling and optimal functioning of the device.

The operation manual shall be read before commissioning the equipment and it shall be provided to all staff involved in transport, installation, operation, maintenance and repair.

The operation manual may not be used for the purposes of competition without the written consent of E+E Elektronik® and may not be forwarded to third parties. Copies may be made for internal purposes. All information, technical data and diagrams included in these instructions are based on the information available at the time of writing.

1.1 Explanation of symbols



This symbol indicates safety information.

It is essential that all safety information is strictly observed. Failure to comply with this information can lead to personal injuries or damage to property. E+E Elektronik® assumes no liability if this happens.



This symbol indicates instructions.

The instructions shall be observed in order to reach optimal performance of the device.

1.2 Safety Instructions

1.2.1 General safety instructions



- Avoid any unnecessary mechanical stress and inappropriate use.
- When replacing the filter cap make sure not to touch the sensing elements.
- For sensor cleaning and filter cap replacement please see “Cleaning instructions” at www.epluse.com.
- Installation, electrical connection, maintenance and commissioning shall be performed by qualified personnel only.

1.2.2 Mounting, start-up and operation

The device has been produced under state of the art manufacturing conditions, has been thoroughly tested and has left the factory fulfilling all safety criteria.

The manufacturer has taken all precautions to ensure safe operation of the device. The user must ensure that the device is set up and installed in a manner that does not have a negative effect on its safe use.

The user is responsible for observing all applicable safety guidelines, local and international, with respect to safe installation and operation on the device. This operating manual contains information and warnings that must be observed by the user in order to ensure safe operation.

- Mounting, start-up, operation and maintenance of the device may be performed by qualified staff only. Such staff must be authorized by the plant operator to carry out the mentioned activities.
- The qualified staff must have read and understood this operating manual and must follow the instructions contained within.
- All process and electrical connections shall be thoroughly checked by authorized staff before putting the system into operation.
- Do not install or start start-up a device supposed to be faulty. Make sure that such devices are not accidentally used by marking them clearly as faulty.
- A faulty device may only be investigated and possibly repaired by qualified, trained and authorized staff. If the fault cannot be fixed, the device shall be removed from the system.
- Service operations other than described in this operating manual may only be performed by the manufacturer.

1.2.3 Intended Use

The EE371 is intended for the measurement of dew point temperature (Td), frost point temperature (Tf) and volume concentration (Wv) in air (compressed air) and other non-corrosive and non-flammable gasses, depending on the model up to 20 bar (290 psi) respectively 100 bar (1450 psi). The use of the EE371 other than described in this manual is not allowed.

The manufacturer cannot be held responsible for damages as a result of incorrect handling, installation and maintenance of the device.

Unauthorized modifications of the product lead to loss of all warranty claims. The device may only be powered with separated extra-low voltage (SELV).

Disclaimer

The manufacturer or his authorized agent can be only be held liable in case of willful or gross negligence. In any case, the scope of liability is limited to the corresponding amount of the order issued to the manufacturer. The manufacturer assumes no liability for damages incurred due to failure to comply with the applicable regulations, operating instructions or the operating conditions. Consequential damages are excluded from the liability.

1.3 Environmental aspects



Products from E+E Elektronik® are developed and manufactured observing of all relevant requirements with respect to environment protection. Please observe local regulations for the device disposal.



For disposal, the individual components of the device must be separated according to local recycling regulations. The electronics shall be disposed of correctly as electronics waste.

2 Product description

2.1 General

Modell T:

The EE371 transmitter features two freely selectable and scalable outputs for Td, Tf or Wv.

Modell S:

The EE371 switch has two relay outputs for control and alarm purposes. The status of the two relays (configured for instance for early warning and main alarm) is indicated by LEDs.

The analogue outputs as well as the Td/Tf switch threshold and hysteresis can be set with the EE-PCS Product Configuration Software, free download from www.epluse.com/configurator.

2.2 Dimensions in mm (inch)

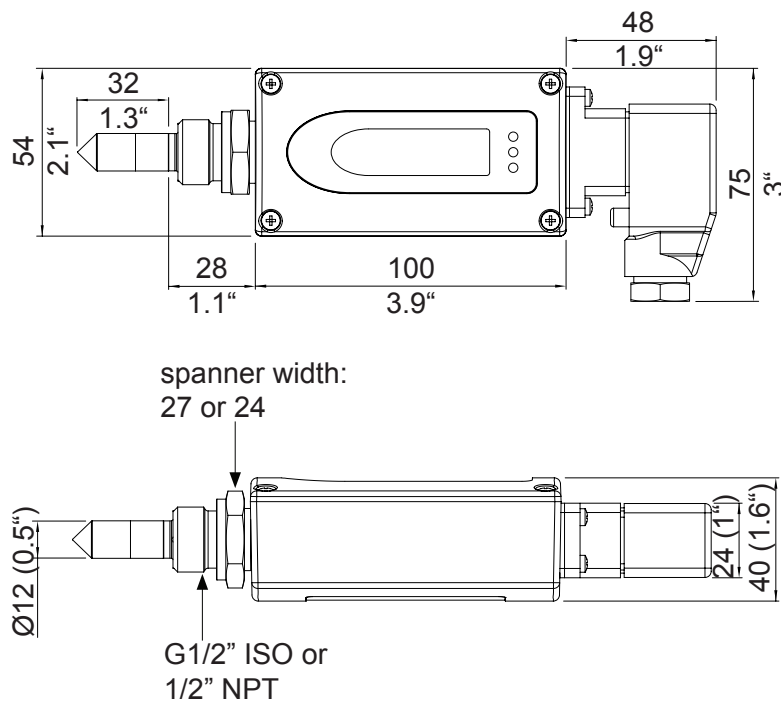

2.3 Auto-calibration

A special auto-calibration procedure leads to high-precision measurement even in the low Td range. The auto-calibration is performed every 30 minutes and takes approx. 3 minutes. During the auto-calibration, the analogue outputs are frozen at the last measured value.

2.4 Output scale; Output signal limitation

The Td analogue output can be scaled within the range -100...80 °C (-148...176 °F).

For air (gas) temperature $T_a \leq 20$ °C (≤ 68 °F), the output is limited at $T_d = -80$ °C (-112 °F)

For air (gas) temperature $T_a > 20$ °C (≤ 68 °F), the output is limited at $T_d = T_a - 100$ °C ($T_a - 180$ °F)

Example (see also Fig.1):

For air (gas) temperature $T_a = 30$ °C (86 °F) the output is limited at $T_d = 30$ °C - 100 °C = -70 °C (86 °F - 180 °F = -94 °F).

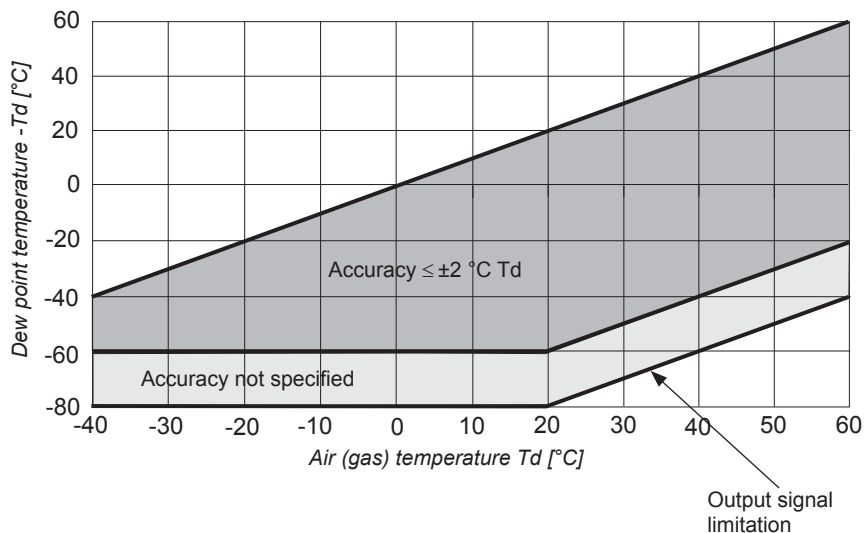

Fig. 1 Dew point measurement range and specified accuracy

The maximum scaling of the analogue output is -100...80 °C (-148...176 °F) dew point.

3 Installation

3.1 Installation location



Upon delivery the sensor is protected by a cap that keeps the dew point sensor dry. The cap should only be removed immediately before installation into the application.

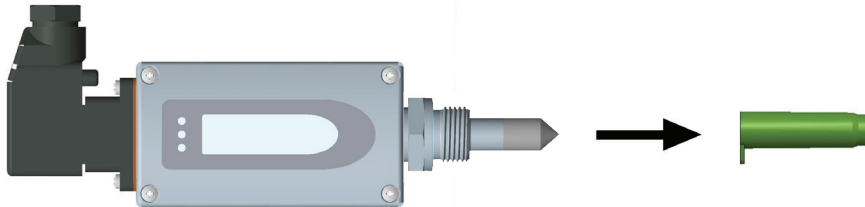

Fig. 2 Remove protection cap

For accurate measurement and short response time, the sensing head shall be immersed in the air or gas to be monitored. The mounting of EE371 shall be tight; moisture ingress from the surroundings falsify the measurement results.

Temperature gradients in the process do not affect the Td measurement. Pressure gradients and variations have a strong impact on the Td measurement. For evaluating these influences the E+E Humidity Calculator, free download from www.humidity-calculator-online.com or as free App for iOS and Android.

3.2 Direct mounting into the process

For direct mounting (without a sampling cell) of the EE371 into the process, it is highly recommended to install stop valves on both sides of the mounting location. This facilitates removing the transmitter for maintenance and calibration.

Insert the probe into the process and screw it first by hand, check the correct positioning of the sealing ring. Use an appropriate wrench to tighten with a torque of 30 Nm.

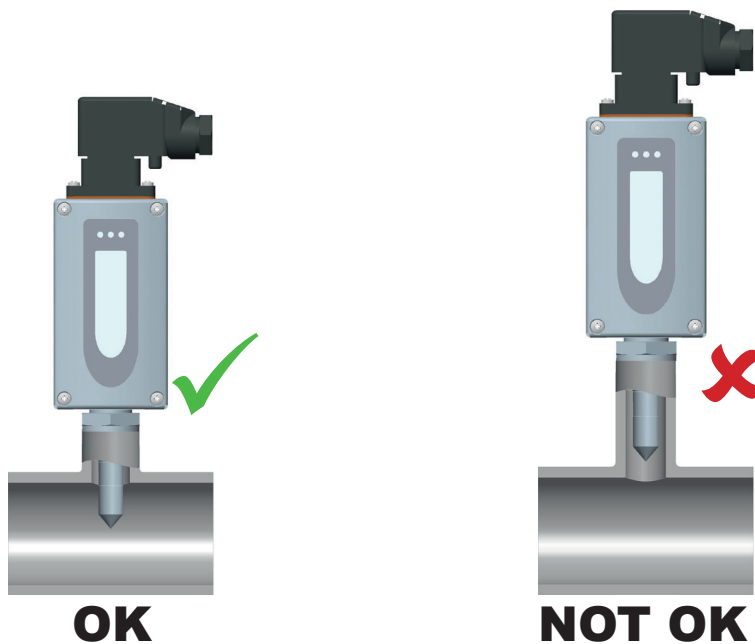

Fig. 3 Direct mounting into the pipe



Sealing rings may not be used with a NPT 1/2" thread. Use appropriate PTFE sealing tape or sealant.

3.3 Mounting with a sampling cell

EE371 mounting with a sampling cell is recommended:

- in case of high process temperature
- for keeping the sensing head out of the main air (gas) stream
- for easy installing / removing the probe without process disruption.

Please note:

- Pressure gradients between the process and the sampling chamber lead to significant measuring errors.
- The mounting of EE371 with sampling cell shall be tight; moisture ingress from the surroundings falsify the measurement results. Do not employ any hygroscopic materials for mounting EE371 or the sampling cell.
- Keep the sampling line as short as possible.
- The response time increases for air (gas) flow < 1 l/min (0.25 gpm).
- A too low gas flow can result in back-diffusion of humidity from the environment and consequently to false measurement.

3.3.1 Basic sampling cell

Pressure range: 0...64 bar (0...928 psi)

Order code: HA050103 (ISO) HA050105 (NPT)

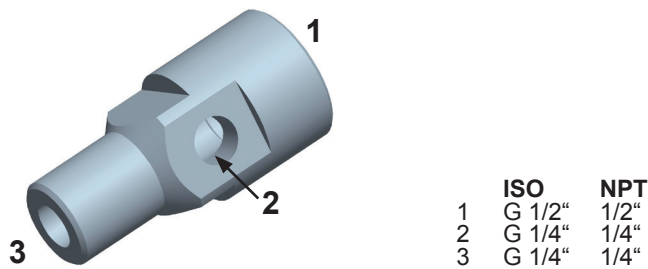

Fig. 4 Basic sampling cell

3.3.2 Sampling cell with quick connector

The sampling cell features a quick-connector suitable for standard compressed air connections DN7.2. It allows the cell to be installed and removed without process interruption.

The air (gas) flow along the sensing head of EE371 can be adjusted using the bleed screw.

Pressure range: 0...10 bar (0...145 psi)

Order code: HA050102

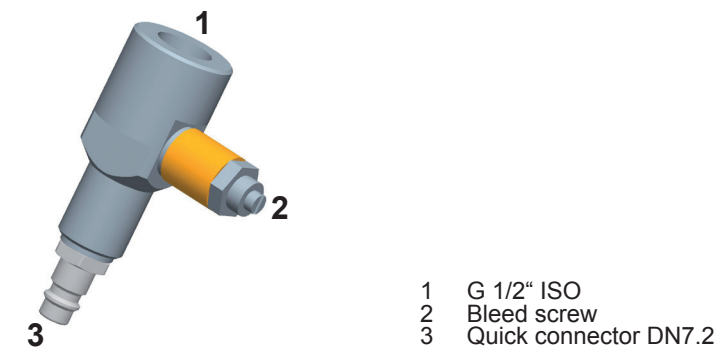
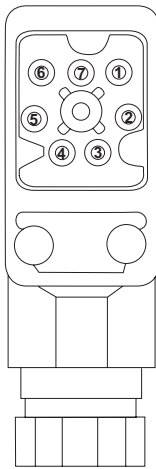

Fig. 5 Sampling cell with quick connector

4 Electrical Connection

The electrical connection is made via the 7-pin connector DIN VDE 0627 / IEC 61984. An mating connector is included in scope of supply.

Analogue output



- 1 V+ 10...30V DC
- 2 GND
- 3 GND
- 4 OUT1
- 5 OUT2
- 6 NC
- 7 NC

Relay output

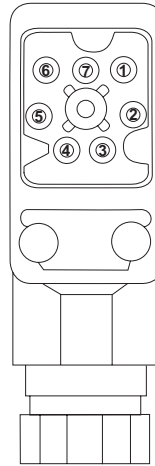

- 1 V+ 10...30V DC
- 2 GND
- 3 NC11
- 4 NC12
- 5 NC21
- 6 NC22
- 7 not connected

The switching thresholds are factory set:

RELAIS 1:

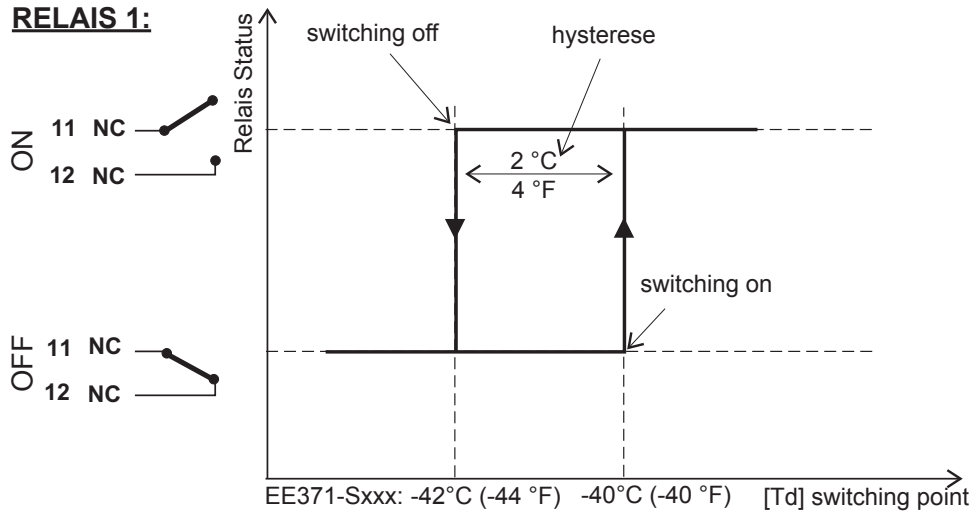

RELAIS 2:

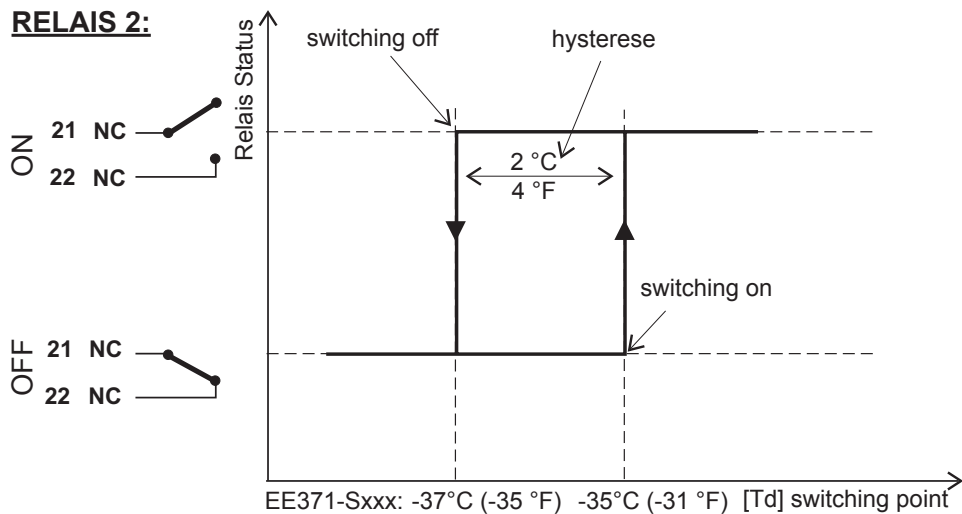

5 Operating components

5.1 Electronics board

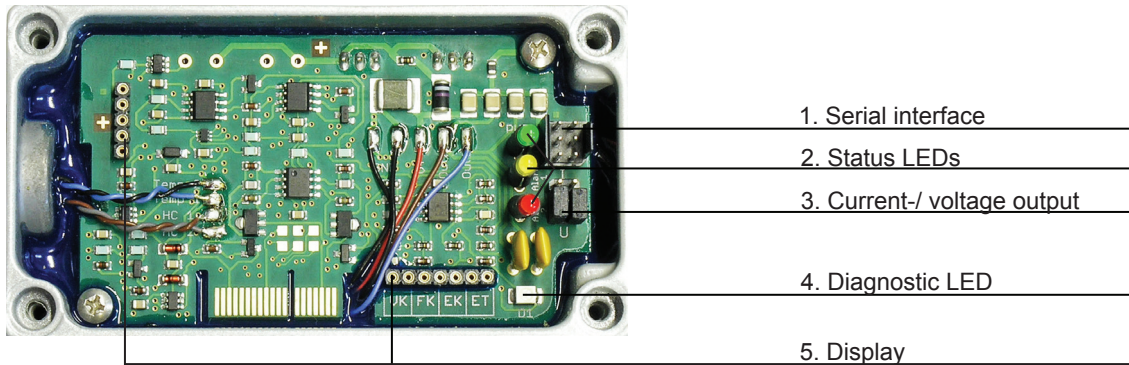

1. Serial interface:

Connector for serial interface cable HA010604 or EE-PCA Product Configuration Adapter with HA011063. See data sheets EE371, Accessories and EE-PCA at www.epluse.com/ee371.

2. Status LEDs:

Provide information on the status of the EE371. See chapter „5.2 Status LEDs”.

3. Current-/ voltage output:

Jumpers for selecting the analogue output signal. The change from voltage to current or vice versa shall be performed both via hardware (jumpers) and software (with the EE-PCS Product Configuration Software).

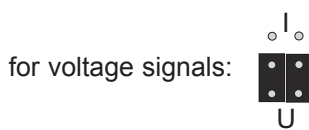
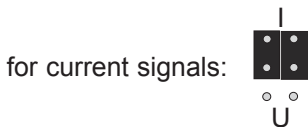

4. Diagnostic LED:

Error indication. See chapter „8.2 Self-diagnostic and error messages”.

5. Display:

Connectors for the optional display module.

5.2 Status LEDs



Green (Power LED):

flashing = EE371 is correctly powered

Yellow / Red :

The yellow and red LEDs are only enabled at model S (switch output):

- yellow LED on continuously: relay 1 is activated
- red LED on continuously: relay 2 is activated

The yellow and red LEDs have no function at model T (analogue output).

5.3 Display Module (Option)

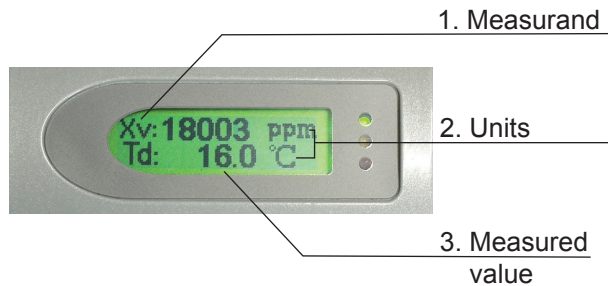

		2. Units:	
		SI	US
Td	dew point temperature	°C	°F
Tf	frost point temperature	°C	°F
Wv	volume concentration	ppm	ppm

3. Measured value:

		EE371
Td	-60...60 °C Td (-112...140 °F Td)	
Tf	-60...0 °C Tf *) (-112...32 °F Tf)	
Wv	20...200 000 ppm	

*) over 0 °C dew point will be displayed

6 Setup

The EE371 probe is ready to use and does not require any configuration by the user. The factory setup of EE371 corresponds to the type number ordered.

The scaling of the analogue output and settings of the relay thresholds can be changed with the free EE-PCS Product Configuration Software, free download at www.epluse.com/configurator

Use either the serial interface cable HA010604 or the EE-PCA Product Configuration Adapter with the cable HA011063 to connect the EE371 to a PC.

7 Calibration / Adjustment

7.1 Definitions

Calibration

The calibration documents the accuracy of a measurement device. The device under test (specimen) is compared with the reference and the deviations are documented in a calibration certificate. During the calibration, the specimen is not changed or improved in any way.

Adjustment

The adjustment improves the measurement accuracy of a device. The specimen is compared with the reference and brought in line with it. An adjustment can be followed by a calibration which documents the accuracy of the adjusted specimen.

The dew point temperature adjustment of EE371 can be performed with the free EE-PCS Product Configuration Software, free download at www.epluse.com/configurator

7.2 Customer adjustment - Dew Point

The dew point adjustment can only be performed if the span between the air or gas temperature T_a and the reference dew point temperature T_d is higher 60 °C (108 °F).

Example:

For $T_a = 20$ °C (68 °F), the reference T_d must be < -40 °C (-40 °F).

8 Maintenance

8.1 Sensor cleaning and filter replacement



Please see “Cleaning instructions” at www.epluse.com.

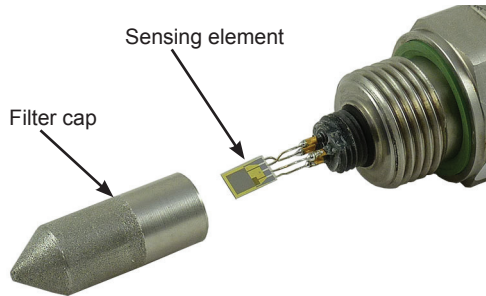

Fig. 6 EE371 Filter and Sensor

8.2 Self-diagnostic and error messages

Self-diagnostic via LED on the circuit board:

Power LED (green):

- flashing => EE371 is correctly powered / the microprocessor is active
- constantly lit => Electronics defect => please contact the producer

LED D1 (blue):

- constantly lit => The sensing element is damaged
- flashing => The sensing element is wet (condensation)

Self-diagnostic via display (option):

- Error 1 => The humidity sensing element is damaged
- Error 2 => The sensing element is wet (condensation)
- Error 3 => The temperature sensing element is damaged
- Error 4 => Short circuit on the temperature sensing element

9 Accessories

Description	Order code
Sampling cell with quick connector	HA050102
Basic sampling cell ISO	HA050103
Basic sampling cell NPT	HA050105
Sampling cell for ambient pressure	HA050106
Stainless steel sintered filter (included in the scope of supply)	HA010103

9.1 Scope of Supply

- Dew point transmitter
- Mating connector
- Quick user guide
- Calibration Certificate acc. DIN EN 10204-3.1

10 Technical Data

Measuring Quantities

Dew point (Td)

Dew point sensor

HMC01

Measuring range

-60...60 °C Td (-76...140°F Td)

Accuracy

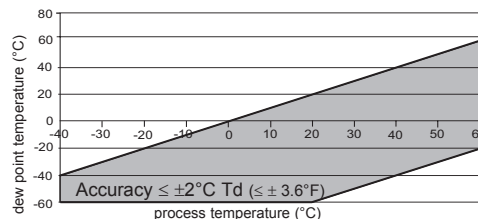

Response time t_{90}

80 sec. -20 °C Td → -40°C Td (-4 °F Td → -40 °F Td)
 10 sec. -40 °C Td → -20°C Td (-40 °F Td → -4 °F Td)

Volume concentration

Measuring range

20...200,000ppm

Accuracy at 20°C (68°F) and 1013mbar

±(5 ppm + 9 % from measured value)

Outputs

EE371-Tx two freely selectable and scaleable analogue outputs for Td, Tf, Wv

0 - 1 V / 0 - 5 V / 0 - 10 V¹⁾ -1 mA < I_L < 1 mA
 4 - 20 mA / 0 - 20 mA R_L < 500 Ohm¹⁾

EE371-Sx Alarm output

2 potential-free relays (NC)
 30 V DC 0.6 A / 35V AC 0.3 A (resistive)

General

Supply voltage

10...30 V DC

Current consumption at 24V DC

voltage output: typ. 40 mA / during auto-calibration: 100 mA
 current output: typ. 80 mA / during auto-calibration: 140 mA

Pressure range

0...20 bar (0...290 psi) / 0...100 bar (0...1450 psi)

System requirements for software

WINDOWS 2000 or later; serial interface

Serial interface for configuration

RS232C

Housing / protection class

Al Si 9 Cu 3 / IP65

Electrical connection

7-pole industrial plug: DIN VDE 0627 / IEC 61984
 cable cross-section: 0.25 - 1 mm²
 cable connection: PG 11

Sensor protection

stainless steel sintered filter

Working temperature range

probe: -40...70 °C (-40...158 °F)
 electronic: -40...60 °C (-40...140 °F)
 with LC display: -20...50 °C (-4...122 °F)

Storage temperature range

-40...60 °C (-40...140 °F)

Electromagnetic compatibility according to

EN 61326-1 EN61326-2-3 ICES-003 ClassB
 Industrial Environment FCC Part15 ClassB

1) minimum supply voltage 15 V DC



HEADQUARTERS

E+E Elektronik Ges.m.b.H.

Langwiesen 7
A-4209 Engerwitzdorf
Austria
Tel: +43 7235 605 0
Fax: +43 7235 605 8
info@epluse.com
www.epluse.com

SUBSIDIARIES

E+E Elektronik Germany

info@epluse.de

Office Bad Homburg
Tel: +49 6172 13881-0

Office Hamburg
Tel: +49 160 9050 6460

Office Stuttgart
Tel: +49 151 538 37 500

E+E Elektronik Italy

info@epluse.it
Tel: +39 02 2707 86 36

E+E Elektronik France

info@epluse.fr
Tel: +33 4 74 72 35 82

E+E Elektronik USA

office@epluse.com

Office Boston
Tel: +1 508 530 3068

Office Chicago
Tel: +1 847 490 7813

E+E Elektronik Korea

Tel: +82 31 732 6050
info@epluse.co.kr

E+E Elektronik China

info@epluse.cn

Office Beijing
Tel: +86 10 8499 2361

Office Shanghai
Tel: +86 21 6117 6129

Office Guangzhou
Tel: +86 20 3898 7052

YOUR PARTNER IN SENSOR TECHNOLOGY



ELEKTRONIK®
Ges.m.b.H.